

**Industrial L2+ Multi-Port Full Gigabit
Managed Ethernet Switch**

**IGS-5225-4T2S/IGS-5225-4P2S/IGS-5225-4UP1T2S/
IGS-5225-4UP1T2S-12V/IGS-5225-8P4S/IGS-5225-8P4S-12V/
IGS-5225-8P2T2S/IGS-5225-8P2T4S**

Quick Installation Guide

Table of Contents

1. Package Contents	3
2. Requirements	5
3. Wiring the Power Inputs.....	6
3.1 Grounding the Device.....	10
4. Terminal Setup	11
4.1 Logging on to the Console	12
4.2 Configuring IP address	14
5. Starting Web Management	16
5.1 Logging in to the Industrial Managed Switch	16
5.2 Saving Configuration via Web	19
6. Recovering Back to Default Configuration.....	20
7. Customer Support	22

1. Package Contents

Thank you for purchasing PLANET L2+ Industrial Managed Switch, IGS-5225 Series. The number of the ports of these models is as follows:

Model No.	Spec.	GbE Copper Ports	PoE Ports		GbE SFP Ports	
			at	bt*	1G	2.5G*
IGS-5225-4T2S		4	-	-	-	2
IGS-5225-4P2S		4	4	-	-	2
IGS-5225-4UP1T2S		5	-	4	-	2
IGS-5225-4UP1T2S-12V		5	-	4	-	2
IGS-5225-8P4S		8	8	-	2	2
IGS-5225-8P4S-12V		8	8	-	2	2
IGS-5225-8P2T2S		10	8	-	-	2
IGS-5225-8P2T4S		10	8	-	2	2

*bt: Compatible with 802.3at PoE

*2.5G: Compatible with 1000BASE-SX/LX/BX SFP transceiver

“Industrial Managed Switch” mentioned in this Quick Installation Guide refers to the above models.

Open the box of the **Industrial Managed Switch** and carefully unpack it. The box should contain the following items for each model of the Industrial Managed Switches:

	The Industrial Managed Switch	Quick Installation Guide Sheet	Wall Mounting Kit	DB9 to RJ45, RS232 Console Cable	RJ45 Dust Cap	SFP Dust Cap
IGS-5225-4T2S	■	■	■	■	5	2
IGS-5225-4P2S	■	■	■	■	5	2
IGS-5225-4UP1T2S	■	■	■	■	6	2
IGS-5225-4UP1T2S-12V	■	■	■	—	6	2
IGS-5225-8P4S	■	■	■	■	9	4
IGS-5225-8P4S-12V	■	■	■	■	9	4
IGS-5225-8P2T2S	■	■	■	■	11	2
IGS-5225-8P2T4S	■	■	■	■	11	4

If any of these are missing or damaged, please contact your dealer immediately. If possible, retain the carton including the original packing materials to enable you to repack the product in case there is a need to return it to us for repair.

2. Requirements

The Industrial Managed Switch provides remote login interface for management purposes. The following equipment is necessary for further management:

- **Workstations** running Windows 7/8/10/11, mac OS 10.12 or later, Linux Kernel 2.6.18 or later, or other modern operating systems are compatible with TCP/IP Protocols.
- Workstations are installed with Ethernet NIC (Network Interface Card).
- Serial Port Connection (Terminal)
 - The above Workstations come with **COM Port** (DB9) or USB-to-RS232 converter.
 - The above Workstations have been installed with **terminal emulator**, such as putty or tera term.
 - **Serial cable** -- one end is attached to the RS232 serial port, while the other end to the console port of the Industrial Managed Switch.
- Ethernet Port Connection
 - Network cables -- Use standard network (UTP) cables with RJ45 connectors.
 - The above PC is installed with Web browser.



Note

It is recommended to use Google Chrome, Microsoft Edge or Firefox to access the Industrial Managed Switch. If the Web interface of the Industrial Managed Switch is not accessible, please turn off the anti-virus software or firewall and then try it again.

3. Wiring the Power Inputs

The Upper Panel of the Industrial Managed Switch comes with one 6-contact terminal block. Please follow the steps below to insert the power wire.

1. Insert positive/negative DC power wires into Contacts 1 and 2 for Power 1, or Contacts 5 and 6 for Power 2.

■ **IGS-5225-8P4S/IGS-5225-8P2T2S/IGS-5225-8P2T4S:** DC 48~54V

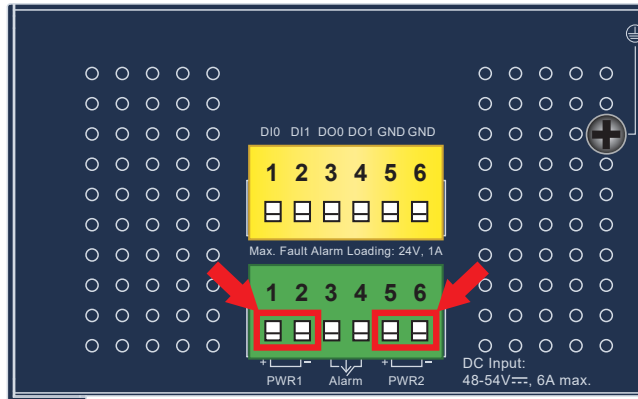

Figure 3-1: IGS-5225-8P4S/IGS-5225-8P2T2S/IGS-5225-8P2T4S Upper Panel

■ **IGS-5225-8P4S-12V:** DC 12~54V

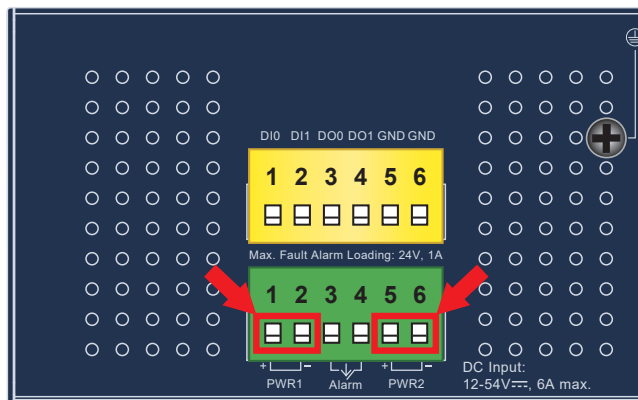

Figure 3-2: IGS-5225-8P4S-12V Upper Panel

■ **IGS-5225-4UP1T2S:** DC 48~54V

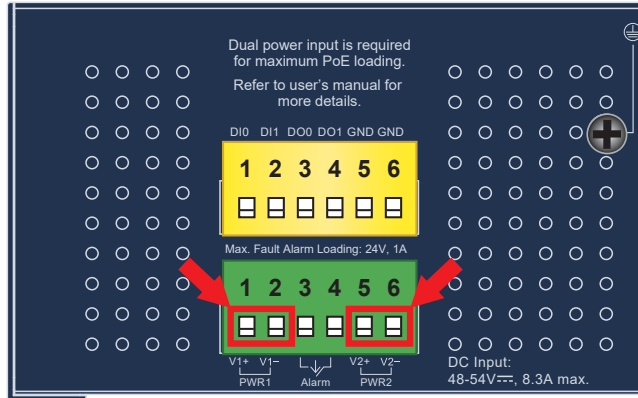

Figure 3-3: IGS-5225-4UP1T2S Upper Panel

■ **IGS-5225-4UP1T2S-12V:** DC 9~54V

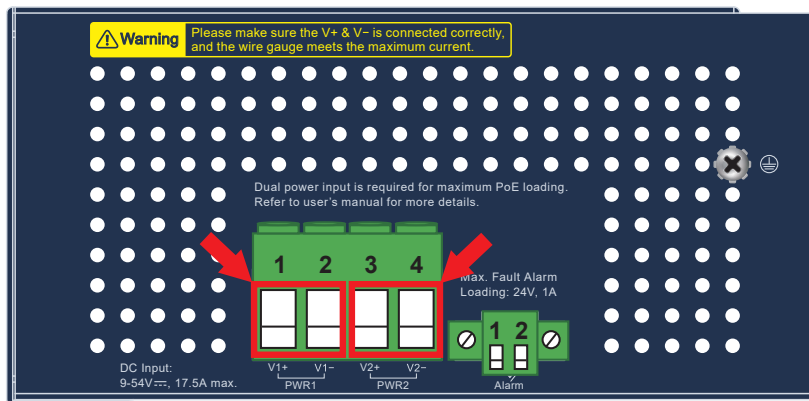

Figure 3-4: IGS-5225-4UP1T2S-12V Upper Panel

■ **IGS-5225-4T2S:** DC 12~48V, AC 24V

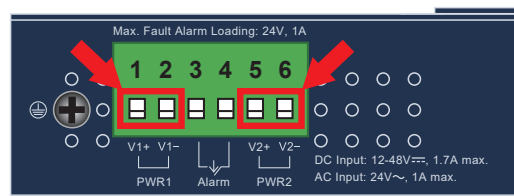

Figure 3-5: IGS-5225-4T2S Upper Panel

■ **IGS-5225-4P2S:** DC 48~54V

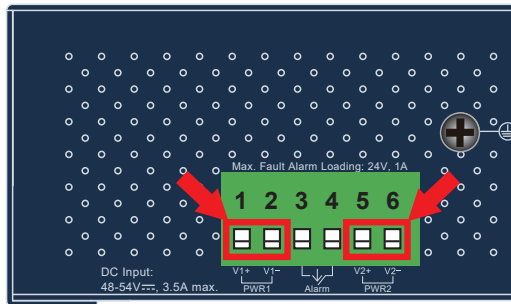
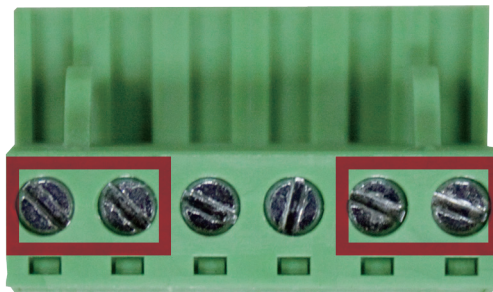

Figure 3-6: IGS-5225-4P2S Upper Panel

2. Tighten the wire-clamp screws for preventing the wires from loosening.



1	2	3	4	5	6
V+	V-			V+	V-
Power 1				Power 2	

	Positive (+) Pin	Negative (-) Pin
IGS-5225 Series	Pin 1/5	Pin 2/6



Note

1. The wire gauge for the terminal block should be in the range from **12** to **24 AWG**.
2. Please check the wire AWG Ampere specification before connecting PLANET Industrial Managed Switch.

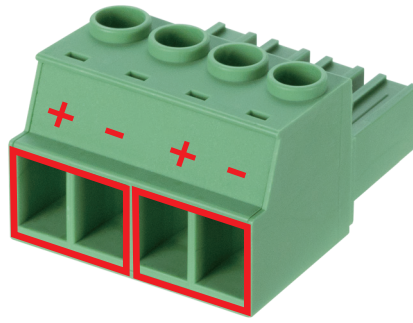

1 2 3 4
 V+ V- V+ V-
 Power 1 Power 2

	Positive (+) Pin	Negative (-) Pin
IGS-5225-4UP1T2S-12V	Pin 1/3	Pin 2/4



Note

1. For the IGS-5225-4UP1T2S-12V, the wire gauge for the terminal block should be in the range from **12** to **20 AWG**.
2. Please check the wire's AWG and ampere specification before connecting PLANET Industrial Managed Switch.



Caution

PWR1 and PWR2 must provide the **same DC voltage** for power load balance while operating with dual power input.

3.1 Grounding the Device

Users **MUST** complete grounding wired with the device; otherwise, a sudden lightning could cause fatal damage to the device.

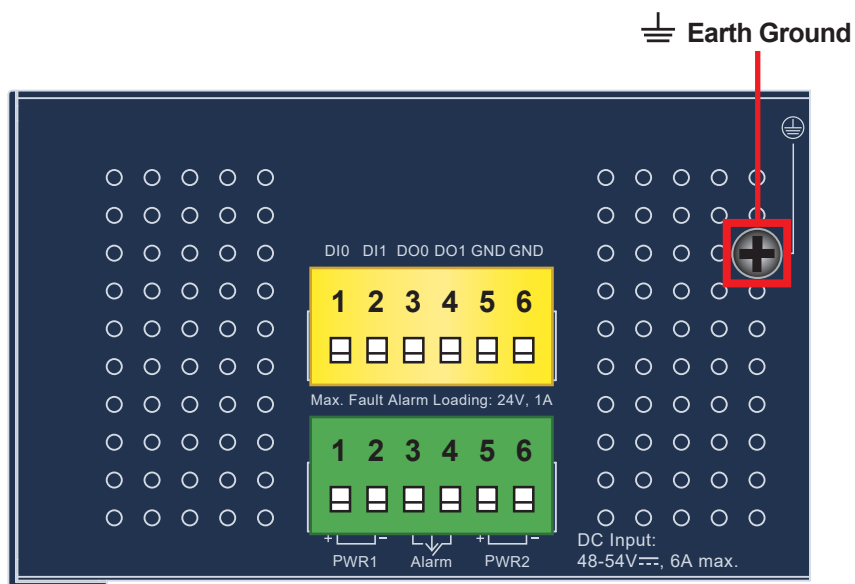
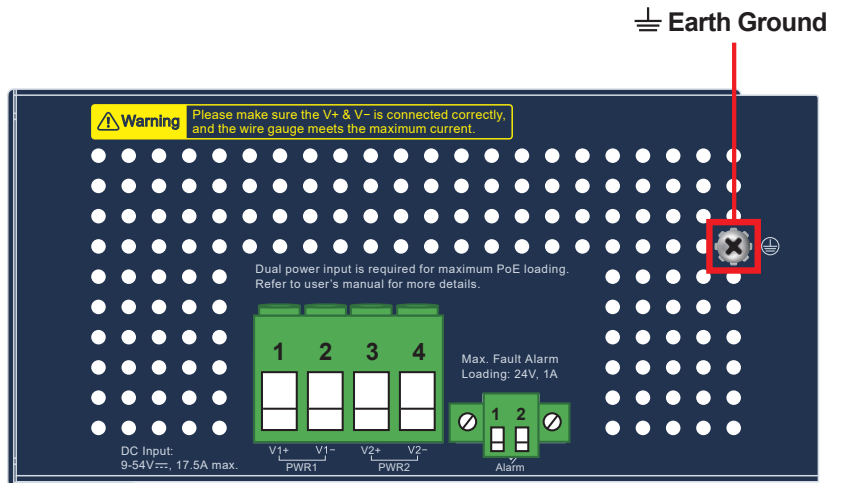

Note

EMD (Lightning) damage is not covered under warranty.

4. Terminal Setup

To configure the system, connect a serial cable to a **COM port** on a PC or notebook computer and to RJ45 type serial (console) port of the Industrial Managed Switch. The console port of the Industrial Managed Switch is DCE already, so that you can connect the console port directly through PC without the need of null modem.

IGS Industrial Managed Switch

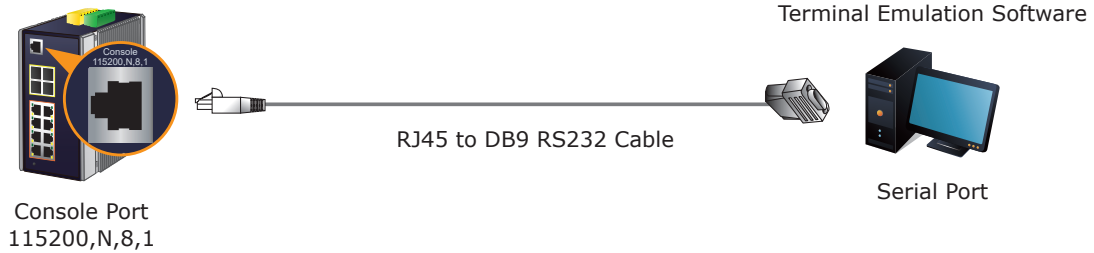

A terminal program is required to make the software connected to the IGS-5225 series Industrial Managed Switch.

1. Run terminal program on the OS.
2. When the following screen appears, make sure that the COM port should be configured as:

- ◆ Baud: 115200
- ◆ Parity: None
- ◆ Data bits: 8
- ◆ Stop bits: 1
- ◆ Flow control: None

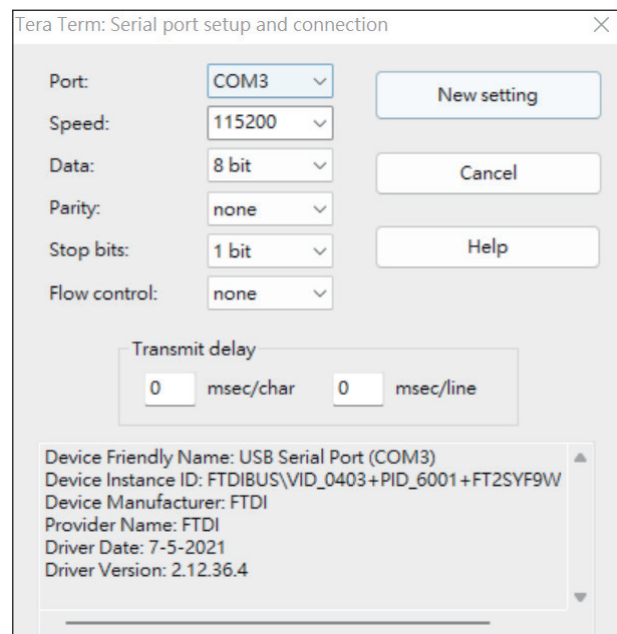

4.1 Logging on to the Console

Once the terminal has been connected to the device, power on the Industrial Managed Switch and the terminal will display "running testing procedures".



Note

The following console screen is based on the IGS-5225-4P2S. The display of the other IGS-5225 series is the same as that of the IGS-5225-4P2S.

Then, the following message asks to log in user name and password. The default user name and password are shown as follows and the login screens in Figure 4-1 & Figure 4-3 appears.



Note

The following console screen is based on the firmware version dated before **February of 2024**.

Username: **admin**

Password: **admin**

```
Now booting linux kernel:
Base address 0x80080000 Entry 0x80100000
Cmdline : init=/usr/bin/stage2-loader loglevel=4
Active fis: linux
[ 0.371610] mx35 spi0.3: NAND Flash Disable (Caracal)
00:00:00 Stage 1 booted
00:00:01 Loading stage2 from NOR flash partition 'linux'
00:00:10 Overall: 9792 ms, ubifs = 530 ms, rootfs 9236 ms of which xz = 0 ms of
which untar = 0 ms
00:00:21 Starting application...
Using existing mount point for /switch/

Press ENTER to get started

Username: █
```

Figure 4-1: Console Login Screen



Note

1. For security reason, **please change and memorize the new password after this first setup**.
2. Only accept command in lowercase letter under console interface.



The following console screen is based on the firmware version dated **February of 2024 or after**.

Username: **admin**

Password: **sw + the last 6 characters of the MAC ID in lowercase**

Find the MAC ID on your device label. The default password is "sw" or "mc" followed by the last six lowercase characters of the MAC ID.

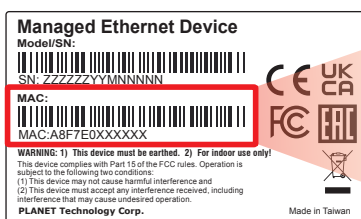

MAC ID: A8F7E0XXXXXX

Default Password: swxxxxxx

("x" means the last 6 digits of the MAC address.

All characters should be in lowercase.)

Figure 4-2: Industrial Managed Switch MAC ID Label

Enter the default username and password, then set a new password according to the rule-based prompt and confirm it. Upon success, press any key to return to the login prompt. Log in with "admin" and the "new password" to access the CLI.

```
Username: admin
Password:

You are required to change and store a new password to be able to
get into the switch.
Please store your new password in a safe, retrievable place for sa
fe keeping.
Once configured, also store a copy of your config file in a safe,
retrievable place for safe keeping.
Password: The password must contain 8-31 characters, including upp
er case, lower case, numerals, and other symbols. Please note, spac
es (blanks) are not accepted.

(New)Password:
Verify (New)Password:
The password is set successfully.

Press ENTER to get started

Username: admin
Password:
IGS-5225-4P2S#
```

Figure 4-3: Create a New Password and Login Again

The user can now enter commands to manage the Industrial Managed Switch. For a detailed description of the commands, please refer to the following chapters.

4.2 Configuring IP address

The Industrial Managed Switch is shipped with default IP address shown below:

```
IP Address: 192.168.0.100  
Subnet Mask: 255.255.255.0
```

To check the current IP address or modify a new IP address for the Switch, please use the procedure as follows:

■ Display of the current IP Address

1. At the “#” prompt, enter “**show ip interface brief**”.
2. The screen displays the current IP address shown in Figure 4-4.

```
IGS-5225-4P2S# show ip interface brief  
Interface Address Method Status  
-----  
VLAN 1 192.168.0.100/24 Manual DOWN  
IGS-5225-4P2S#
```

Figure 4-4: IP Information Screen

■ Configuration of the IP Address

3. At the “#” prompt, enter the following command and press <Enter> as shown in Figure 4-5.

```
IGS-5225-4P2S# configure terminal  
IGS-5225-4P2S(config)# interface vlan 1  
IGS-5225-4P2S(config-if-vlan)# ip address 192.168.1.100 255.255.255.0
```

The previous command would apply the following settings for the Industrial Managed Switch.

```
IP Address: 192.168.1.100  
Subnet Mask: 255.255.255.0
```

```
Press ENTER to get started  
Username: admin  
Password:  
IGS-5225-4P2S# configure terminal  
IGS-5225-4P2S(config)# interface vlan 1  
IGS-5225-4P2S(config-if-vlan)# ip address 192.168.1.100 255.255.255.0  
IGS-5225-4P2S(config-if-vlan)#
```

Figure 4-5: Configuring IP Address Screen

4. Repeat step 1 to check if the IP address has changed.

■ Store the current switch configuration

5. At the “#” prompt, enter the following command and press **<Enter>**.

```
# copy running-config startup-config
```

```
Press ENTER to get started
Username: admin
Password:
IGS-5225-4P2S# configure terminal
IGS-5225-4P2S(config)# interface vlan 1
IGS-5225-4P2S(config-if-vlan)# ip address 192.168.1.100 255.255.255.0
IGS-5225-4P2S(config-if-vlan)# exit
IGS-5225-4P2S(config)# exit
IGS-5225-4P2S# copy running-config startup-config
Building configuration...
% Saving 2736 bytes to flash:startup-config
IGS-5225-4P2S#
```

Figure 4-6: Saving Current Configuration Command Screen

If the IP is successfully configured, the Industrial Managed Switch will apply the new IP address setting immediately. You can access the Web interface of the Industrial Managed Switch through the new IP address.



Note

If you are not familiar with the console command or the related parameter, enter **“help”** anytime in console to get the help description.

5. Starting Web Management

The following shows how to start up the **Web Management** of the Industrial Managed Switch. Note the Industrial Managed Switch is configured through an Ethernet connection. Please make sure the manager PC must be set to the same **IP subnet address**.

For example, the default IP address of the Industrial Managed Switch is **192.168.0.100**, then the manager PC should be set to **192.168.0.x** (where x is a number between 1 and 254, except 100), and the default subnet mask is 255.255.255.0.

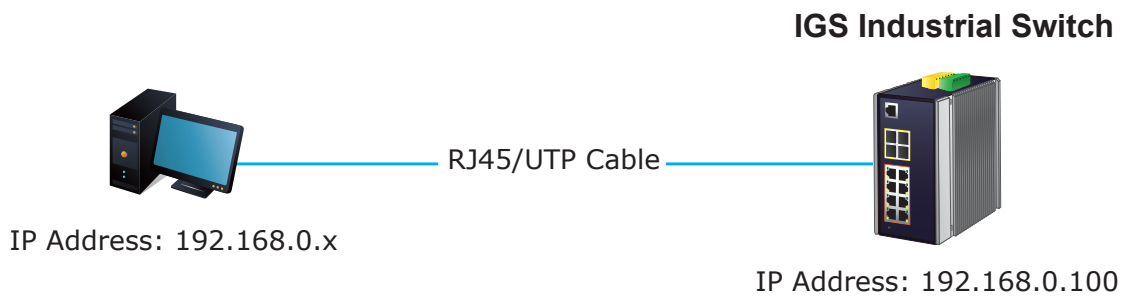

Figure 5-1: IP Management Diagram

5.1 Logging in to the Industrial Managed Switch

1. Use a modern Web browser and enter IP address **<https://192.168.0.100>** (the factory-default IP address) to access the Web interface.



Note

The following web screen is based on the firmware version dated before **February of 2024**.

2. When the following dialog box appears, please enter the default user name "**admin**" and password "**admin**" (or the password you have changed before) as shown in Figure 5-2.
3. After entering the password, the main screen appears as shown in Figure 5-4.

Default IP Address: **192.168.0.100**
Default User Name: **admin**
Default Password: **admin**



The following web screen is based on the firmware version dated **February of 2024 or after**.

- When the following dialog box appears, please enter the default user name **"admin"** and password. Refer to **Section 4.1** to determine your initial login password.

Default IP Address: **192.168.0.100**

Default User Name: **admin**

Default Password: **sw + the last 6 characters of the MAC ID in lowercase**

Authentication required
https://192.168.0.100
Your connection to this site is not private

Username

Password

Figure 5-2: Login Screen

- After logging in, you will be prompted to change the initial password to a permanent one.

Change Password

New Password

Password	<input type="password"/>	<input type="checkbox"/> show password
Retype Password	<input type="password"/>	

The password must contain 8-31 characters, including upper case, lower case, numerals and other symbols. Please note, spaces (blanks) are not accepted.

Figure 5-3: Create a New Password

6. Once the password change is complete, re-enter the web interface using your new password and the main screen appears as Figure 5-4 shows.



Figure 5-4: Web Main Screen of Industrial Managed Switch

The Industrial Managed Switch Menu on the top left of the Web page lets you access all the functions and status the Industrial Managed Switch provides. The Switch Menu always contains one or more buttons, such as **“System”**, **“Switching”**, **“QoS”**, **“Security”**, **“PoE”**, **“Ring”**, **“ONVIF”** and **“Maintenance”**.



Figure 5-5: Switch Menu

Now, you can use the Web management interface to continue the Switch management. Please refer to the user manual for more.

 **Note**

If you are not familiar with Switch functions or the related parameter, press  **“Help icon”** on the Web page to get the help description.

5.2 Saving Configuration via Web

To save all applied changes and set the current configuration as a startup configuration, the startup-configuration file will be loaded automatically across a system reboot.

1. Click the **Save** icon on the top Switch Menu bar.

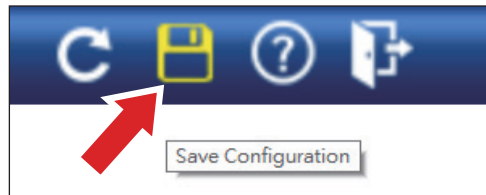
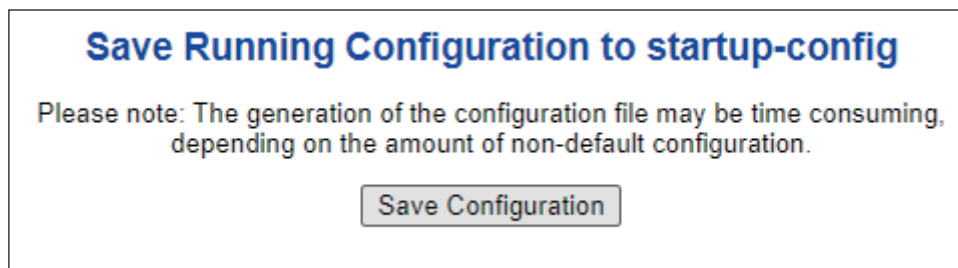

Figure 5-6: Save Config -- Hot Key

2. Press the **"Save Configuration"** button.



3. Or the other way to save the setting is to Click **Maintenance, Save Startup Config**.

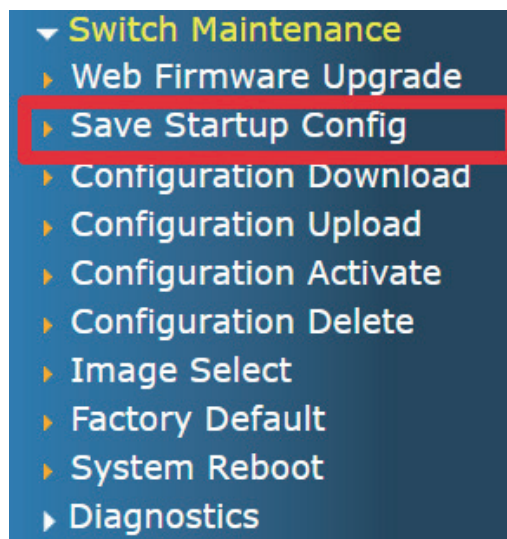

Figure 5-7: Save Config – Maintenance

6. Recovering Back to Default Configuration

To reset the IP address to the default IP address “**192.168.0.100**” and the user password to factory default mode (default password is **admin**), press the hardware reset button on the front panel for about 10 seconds. After the device is rebooted, you can log in the management Web interface within the same subnet of 192.168.0.xx and default password. Be noted that all the previous setups will be disappeared after the factory default reset is made.

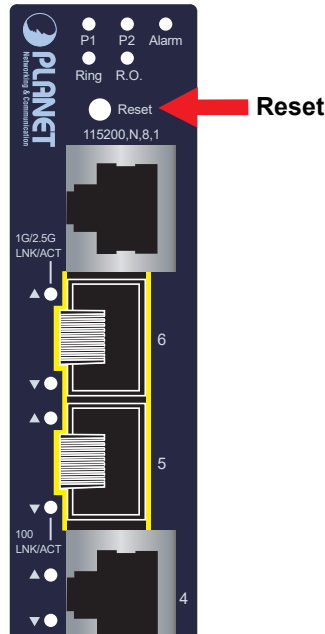

Figure 6-1: IGS-5225-4T2S Reset Button

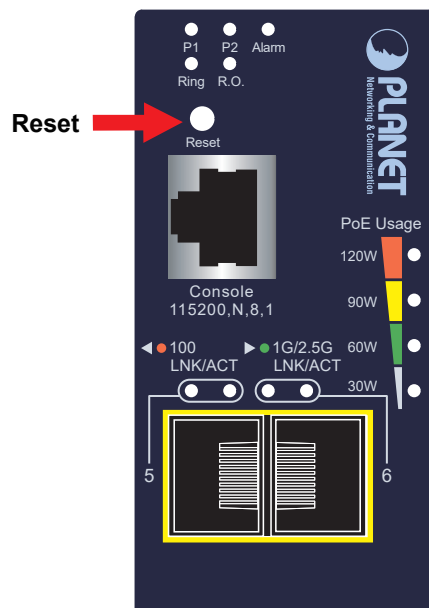

Figure 6-2: IGS-5225-4P2S Reset Button

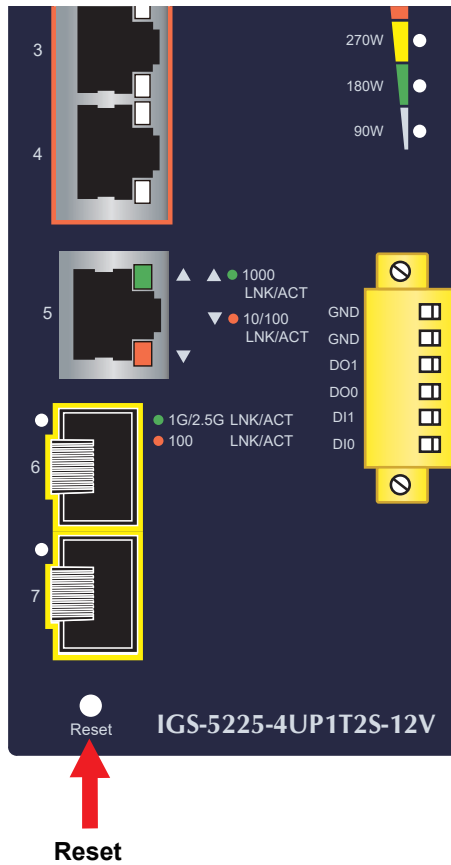

Figure 6-3: IGS-5225-4UP1T2S/IGS-5225-4UP1T2S-12V Reset Button

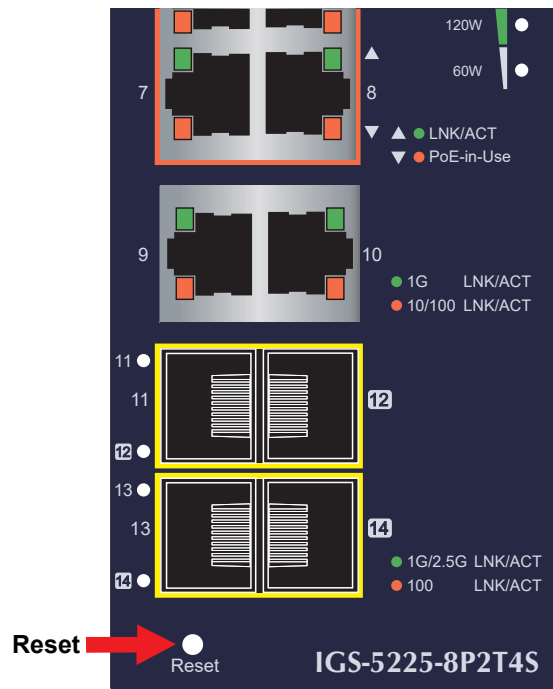

Figure 6-4: IGS-5225-8P4S/IGS-5225-8P4S-12V/
IGS-5225-8P2T2S/IGS-5225-8P2T4S Reset Button

7. Customer Support

Thank you for purchasing PLANET products. You can browse our online FAQ resource on PLANET web site first to check if it could solve your issue. If you need more support information, please contact PLANET switch support team.

PLANET online FAQs:

<https://www.planet.com.tw/en/support/faq>

Switch support team mail address:

support@planet.com.tw

IGS-5225-4T2S/IGS-5225-4P2S/IGS-5225-8P2T4S/IGS-5225-8P4S/IGS-5225-8P4S-12V/
IGS-5225-8P2T2S/IGS-5225-4UP1T2S/IGS-5225-4UP1T2S-12V User's Manual:

<https://www.planet.com.tw/en/support/downloads?&method=keyword&keyword=IGS-5225&view=3#list>



(Please select your switch model name from the Product Model drop-down menu)

Copyright © PLANET Technology Corp. 2024.

Contents are subject to revision without prior notice.

PLANET is a registered trademark of PLANET Technology Corp.

All other trademarks belong to their respective owners.